

Art that
FIGHTS
fire

Technical Data Sheet
SD - EI₂ 60

meverin[®]
F I R E D O O R S

EN FF € EI₂ 60
SLIDING DOOR
1-2 LEAVES

with or without WICKET DOOR



TECHNICAL FEATURES

Top-hung running track

NEW: multifunctional structural horizontal top-hung running track (patented), made in continuous mode in high-strength steel profile, shiny zinc-plated, with built-in safety and anti-slip rack.

The top-hung running track, made to measure, is prepared and pre-drilled for fastening to the support element by means of dowels (dowels not included).

Where the dimensions require a segmentation of the running track, it is supplied with push-fit joints.

Front cover of the running track through a RAL 9006-like pre-painted sheet metal casing included for sliding doors with HN (Net Height) up to 2700 mm (over 2700 optional and on request).

Floor guide (consisting in a combination/set of bearings) positioned on the floor beyond the wall aperture, always supplied.

NEW: Stone Track ground contrast system (patented) designed for fire performance in the large dimensions.

Advanced and alternative system to be preferred to the linear guide on the ground.

Linear guide on the ground included in the supply, expected over LN 4900 mm (length of the guide reduced to 1500 mm). It is advisable to prefer the Stone Track system to this solution.

Hanging system - CARRIER

NEW: FIRE AND SMOKE BARRIER suspension and overhead sliding system (patented) consisting of a continuous steel profile element with vectorial load with integral, balanced, flex-oscillating and millimeter-accuracy carriers for uniform load distribution.

For each modular panel there are carriers equipped with double running track.

Leaf

Made with cut-to-measure modular panels assembled through coplanar male/female push-fit joints (patented) and fixed on both sides by visible screws (the screws are included in the supply).

NEW: upper reinforcing structure for the leaf connected to the carrier and lower reinforcing structure in profiled metal sheet.

Suitably shaped coating metal sheet on the two external faces with programmed deformability.

NEW: MEV FIRUX[®] (patented) continuous internal insulating pack, resistant to high temperatures, available even in large dimensions.

Dynamic overlapping and overall dimensions depending on the size of the sliding door, in compliance with the standard.

Guided and facilitated assembly sequence thanks to the complete preparation of all the details (thoroughly vetted at the factory) and the numerical progression shown on the panels and on the lower reinforcing structure with the absolute advantage of a successful installation and reduced installation times.

Handles

Recessed on both sides of each leaf, positioned so as to retract according to dynamic overlapping.

Smoke labyrinth seals

In press-folded and pre-drilled sheet steel for fixing by means of pre-set screws. The wall side labyrinth seals are completed with an insulating sheet and finished with FIRUX[®] intumescent fire seals.

FIRUX[®] type intumescent fire seal

Placed on all labyrinth seals and between panels.

Cold Smoke Gaskets Sa (optional)

NEW: Cold Smoke Gaskets Sa placed on the perimeter of the fixed and mobile profiles (provided on the male-female joint in the case of two leaves; applied on the perimeter of the frame in the case of a pedestrian door).

NEW: The possibility of installing the KIT Sa, as an integration, even at a later time is foreseen.

Accident prevention safety systems

NEW: hydraulic device (patented) for speed control VTK (Viscotroller[®] Kalipè[®]) – at a slow and short pace – which acts in synergy with the top-hung running track by coupling with the rack, therefore guaranteeing full safety when closing the door leaf with a soft and delicate closure. Life-saving device, innovative, absolute and new generation.

NEW: SAM K, soft close damper, cushions and accompanies the door during the final stage of closing.

Operation (door hold-open retainer)

Standard with electromagnet as per DoP declaration.

Counterbalance weights

Closure with counterbalance weight protected by a RAL 9006-like pre-painted sheet metal casing in the various versions.

- Front
- Offset front
- Opposite side
- **NEW:** attached to the leaf.

Motor

NEW: Motorized system combined with PRIORITY FIRE[®] (patented) for single-leaf doors with front or on-leaf counterweight.

Wicket door (optional)

	Door size			Wicket door aperture dimensions	
	LN (1 leaf)	LN (2 leaves)	HN	LNp	HNp
Wicket door with sill (92 mm)	1580	3500	2250	850	2090
	1870	4000	2250	1140	2090
Wicket door without sill	1580	3500	2200	850	2000
	1870	4000	2200	1140	2000

The measurements are expressed in mm.

For lower LN (Net wall aperture) ask for feasibility.

In the case of a HN (Net Height) lower than the measures listed above, the height of the wicket door (HNp) is to be reduced.

NEW: Optional with visual panel (porthole).

Applications

- Surface mounted on solid and load-bearing masonry or reinforced concrete wall
- On insulated and protected beam or insulated metal structure covered with plasterboard.

Static calculations at the client's responsibility.

Door to be installed indoors and not subject to drafts.

Finish

The sliding doors are made of galvanized sheet metal and finished with an ecological primer paint, of industrial type, with high quality epoxy resins, which guarantee protection against corrosion from a vast range of aggressive agents, acid and non-acid, in environments not directly exposed to the outdoor natural atmosphere. Standard color RAL 7035. A wide range of RAL and NCS is available on order.

NEW: made of AISI 304 or 316 stainless steel (excluding guide-track, Stone Track system and accessories).

Identification plate

Applied on the shell handle with the appropriate CE mark and with personalized polychrome CARD with identification data.

Documentation provided (CE marking)

Composed by:

- DoP declaration of performance
- declaration of conformity with machinery directive
- installation, use and maintenance manual
- installation instructions

EI₂ 60 LEAF weight and thickness

- Average nominal weight 47 kg/m²
- **NEW:** nominal thickness 100 mm

EI₂ 60 field of application with CE marking

	Sliding Door 1 leaf EI ₂ 60		Sliding Door 2 leaves EI ₂ 60	
	LN	HN	LN	HN
Maximum dimensions	10000 mm	8225 mm	10000 mm	8225 mm
Maximum surface	50 mq		50 mq	
Decreasing dimensions	UNLIMITED		UNLIMITED	

COUNTERWEIGHT - FRONT VERSION - CE MARKED - COMPLYING WITH EN 16034 - EN 13241

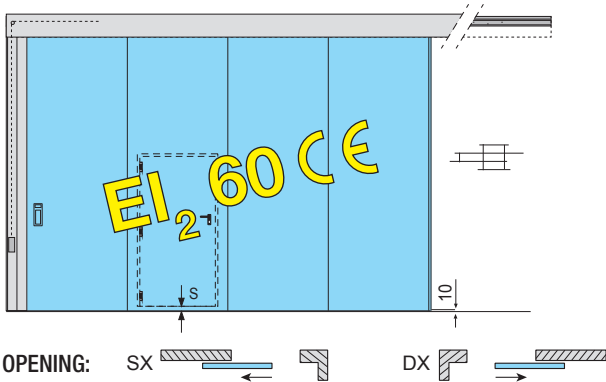

FRONT (STANDARD) COUNTERWEIGHT

On request, angled counterweight to contain the overall dimensions up to 40 mm. ①

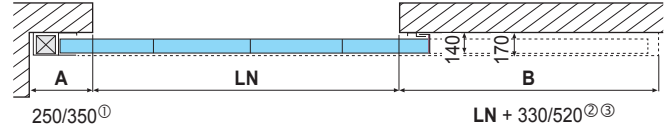

LN	overall dimensions door-stop A ①	overall dimensions opening B ②
up to 2700 mm	250 mm	LN + 330 mm
2701 to 4900 mm	280 mm	LN + 380 mm
4901 to 10000 mm	350 mm	LN + 520 mm

BEAM ON WALL

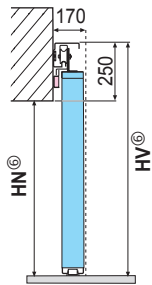

BEAM WITHIN HEIGHT

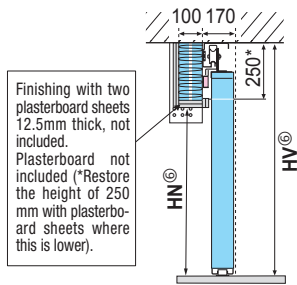

OFF-AXIS COUNTERWEIGHT

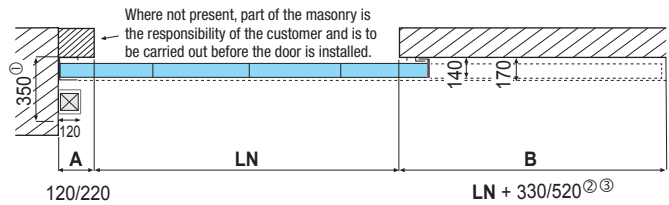

LN	overall dimensions door-stop A	overall dimensions opening B ②
up to 2700 mm	120 mm	LN + 330 mm
2701 to 4900 mm	150 mm	LN + 380 mm
4901 to 10000 mm	220 mm	LN + 520 mm

COUNTERWEIGHT - OPPOSITE-SIDE VERSION - CE MARKED - COMPLYING WITH EN 16034 - EN 13241

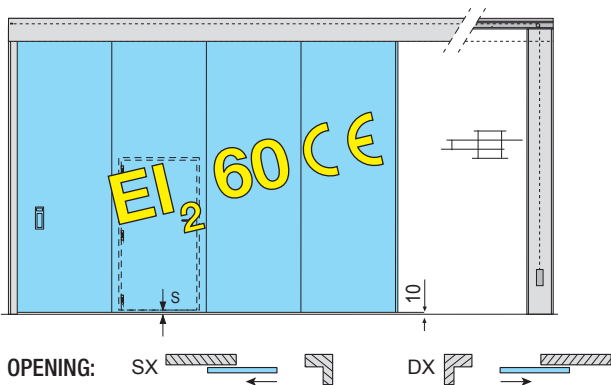

OPPOSITE-SIDE COUNTERWEIGHT

On request, angled counterweight to contain the overall dimensions up to 40 mm. ①

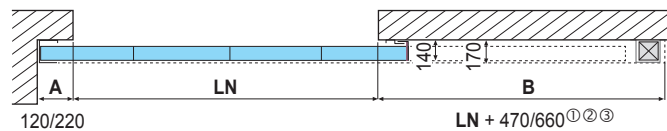

LN	overall dimensions door-stop A	overall dimensions opening B ①②
up to 2700 mm	120 mm	LN + 470 mm
2701 to 4900 mm	150 mm	LN + 520 mm
4901 to 6000 mm	220 mm	LN + 660 mm

BEAM ON WALL

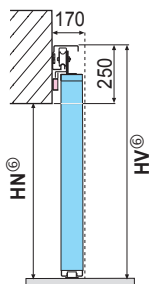

BEAM WITHIN HEIGHT

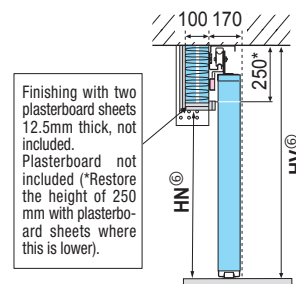

COUNTERWEIGHT ATTACHED VERSION - MARKED CE - COMPLYING WITH EN 16034 - EN 13241

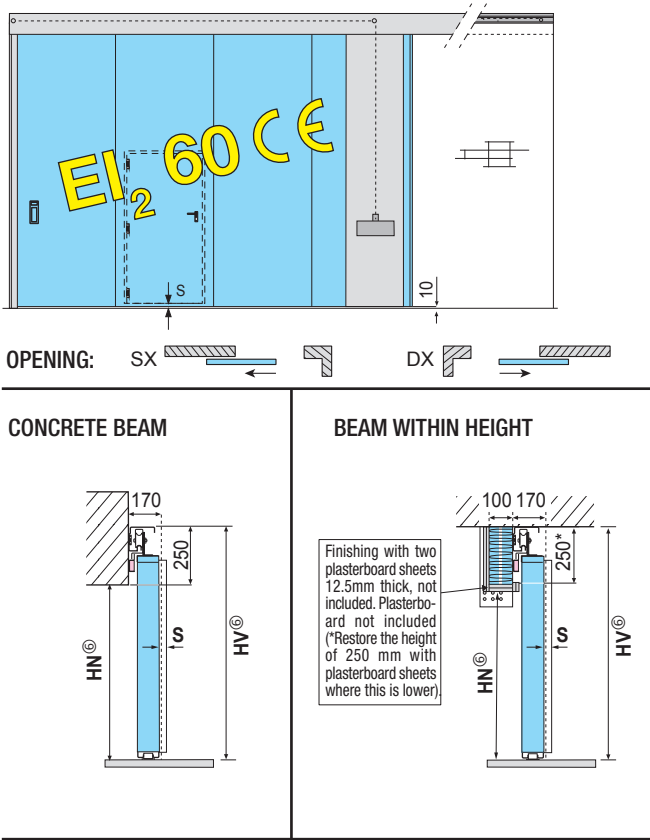

ATTACHED ON-LEAF COUNTERWEIGHT ⑤ ⑦

The position of the counterweights together with the leaf, due to production requirements, may not be at the end of the door.

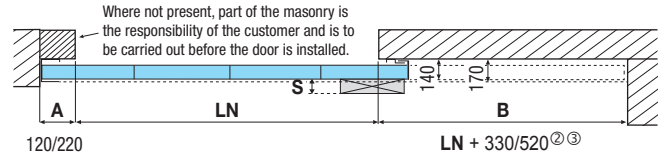

LN	overall dimensions door-stop A	overall dimensions opening B ^②
up to 2700 mm	120 mm	LN + 330 mm
2701 to 4900 mm	150 mm	LN + 380 mm
4901 to 10000 mm	220 mm	LN + 520 mm

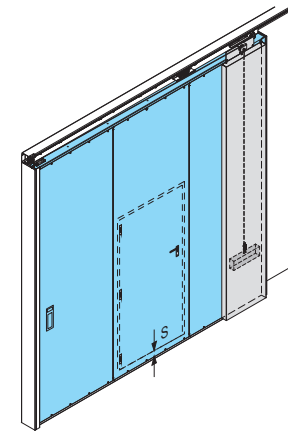

COUNTERBALANCE WEIGHT - NORMAL VERSION 2 LEAVES - CE MARKED - COMPLYING WITH EN 16034 - EN 13241

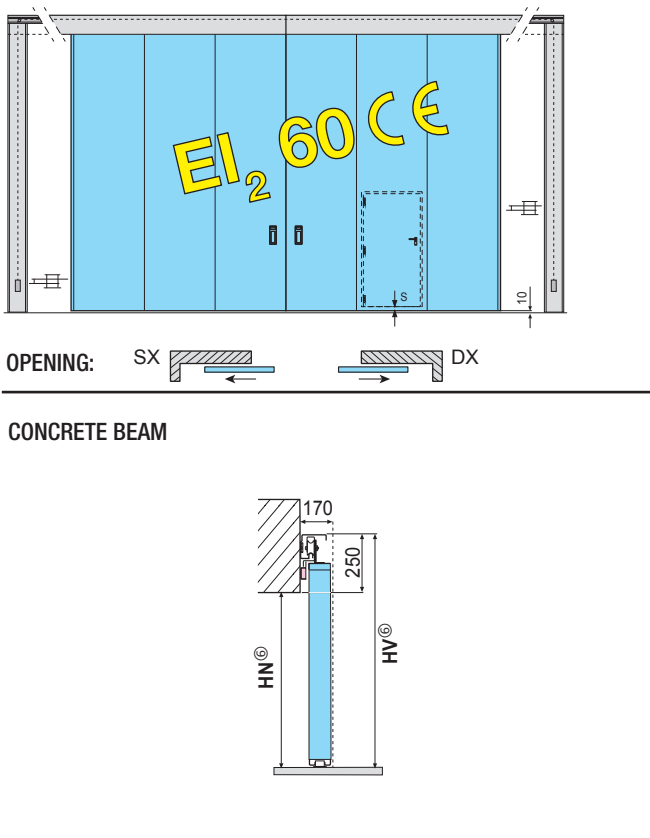

BASE (STANDARD) COUNTERBALANCE WEIGHT

On request, angled counterbalance weight to limit the overall dimensions up to 40 mm per side. ⑧

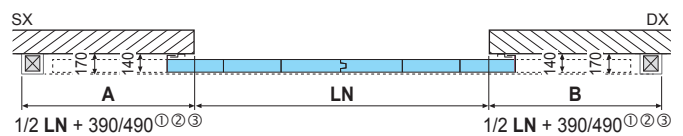

LN	overall dimensions opening A/B ^{① ②}
up to 2700 mm	1/2 LN + 390 mm
2701 to 4900 mm	1/2 LN + 420 mm
4901 to 10000 mm	1/2 LN + 490 mm

BEAM WITHIN HEIGHT

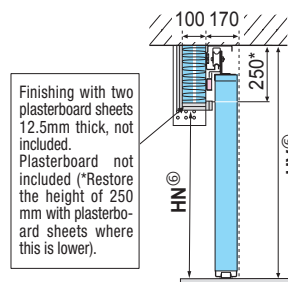

COUNTERWEIGHT - ATTACHED VERSION 2 LEAVES - CE MARKED - COMPLYING WITH EN 16034 - EN 13241

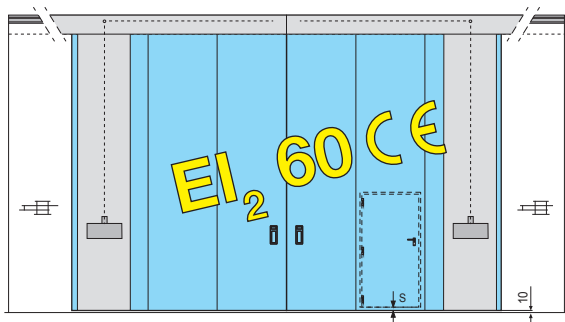

OPENING: SX DX

CONCRETE BEAM

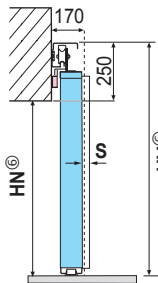

BEAM WITHIN HEIGHT

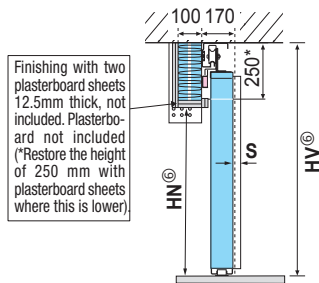

ATTACHED ON-LEAF COUNTERWEIGHT[®]

The position of the counterweights together with the leaf, due to production requirements, may not be at the end of the door.

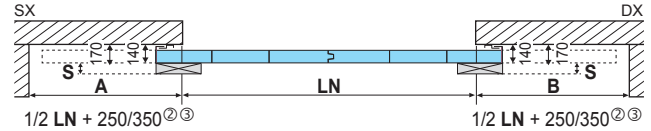

LN	overall dimensions opening A/B [®]
up to 2700 mm	1/2 LN + 250 mm
2701 to 4900 mm	1/2 LN + 280 mm
4901 to 10000 mm	1/2 LN + 350 mm

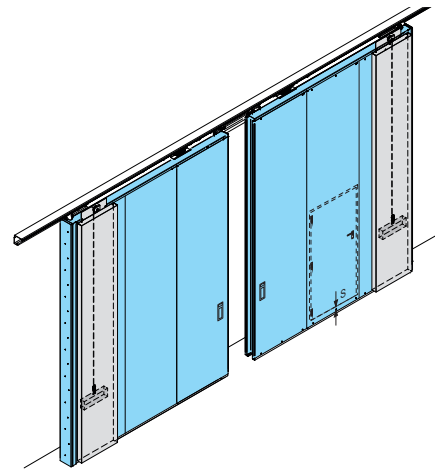

SOLUTION WITH AND WITHOUT GUIDE COVER - FIXED PARTS FINISH

WITHOUT GUIDE-TRACK COVER

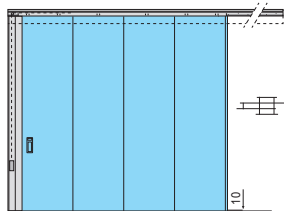

WITH GUIDE-TRACK COVER

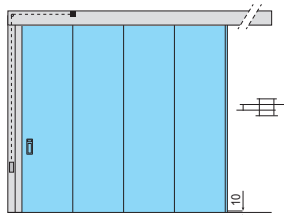

- DOOR LEAF finish in RAL 7035 as standard, or custom RAL color available at extra cost.
- COUNTERWEIGHT COVER and GUIDE COVER supplied as standard in a RAL 9006-like finish, regardless of the door color, or available in the same finish as the door leaf for an extra fee.
- FIXED UPRIGHT supplied in exposed galvanized steel.
- STRIKE PROFILE supplied in exposed galvanized steel.

INSTALLATION OPTIONS:

- MOUNTED ON MASONRY AND REINFORCED CONCRETE
- LINTEL MOUNTED, RECESSED
Fig 1
- MOUNTED ON LOAD-BEARING METAL STRUCTURE
Fig 2

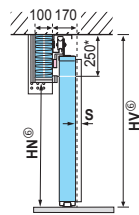

Lintel mounted, recessed in wall aperture 100x250 mm. Plasterboard sheets 12.5mm thick, not included. Plasterboard not included. (*Restore the 250 mm elevation with plasterboard sheets if needed) Rockwool 150kg / mc. Side fixing plates.

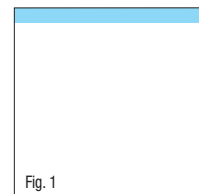

Recessed lintel in insulated steel tube 100x250 mm, for EI₂ 60 sliding doors with one and two leaves. The lintel finishing with 12.5 mm plasterboard sheets is not included.

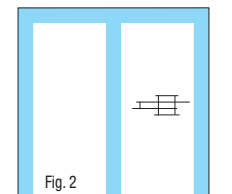

Example of load-bearing structure made in insulated steel tube 100x250 mm, for EI₂ 60 sliding doors with one and two leaves. The lintel finishing with 12.5 mm plasterboard sheets is not included.

EN FF CE EI₂ 60 SLIDING DOOR 1-2 LEAVES

WICKET DOOR (optional)

The wicket door is usually fitted in the 1st module of the sliding doorset after the module housing the handle, unless specifically requested otherwise.

The handing of the wicket door must be chosen according to the handing of the sliding doorset.

STANDARD DOORSILL S= 92 mm

WITHOUT DOORSILL[®] S= 0 mm

LNp 850 mm o 1140 mm

HNp 2090 (HN min 2250 per S=92 mm e HN min 2200 per S=0)

RECOMMENDED OPENINGS

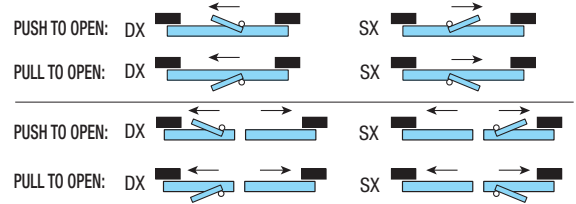

PULL-TO-OPEN WICKET DOOR with handle

(opening of the wicket door towards the side opposite the wall)

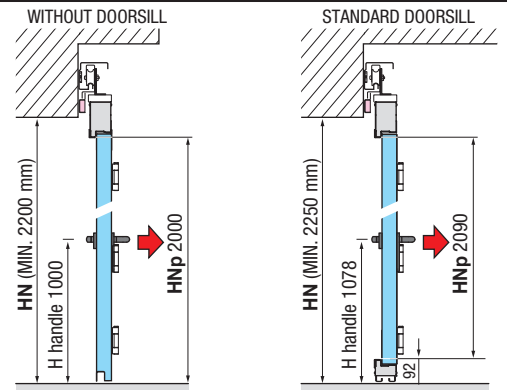
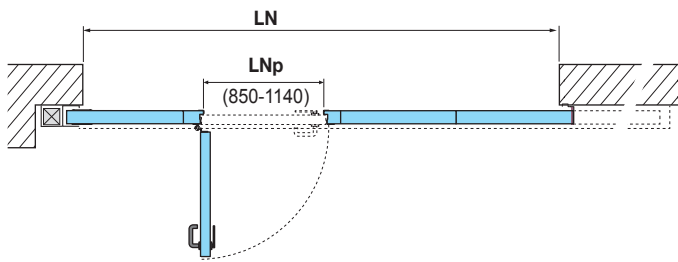

PULL-TO-OPEN WICKET DOOR with easy opening device

(opening of the wicket door towards the side opposite the wall)
 Horizontal and vertical shimming is required.

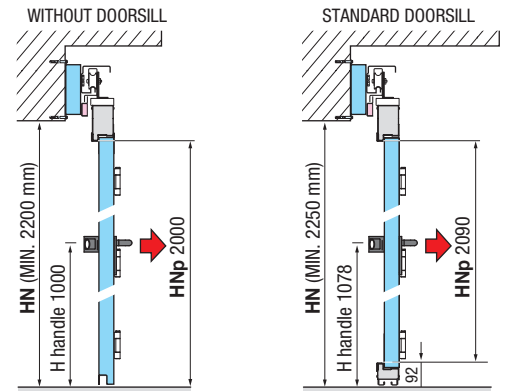
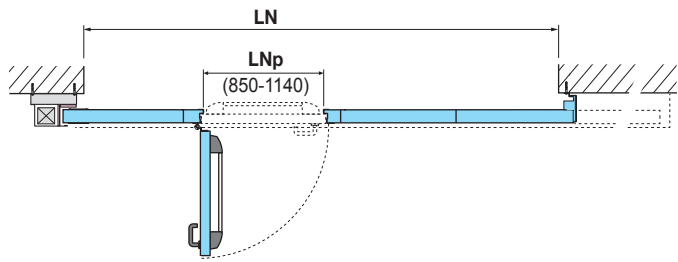

PUSH-TO-OPEN WICKET DOOR with or without easy opening device

(opening of the wicket door towards the wall side)
 Horizontal and vertical shimming is required.

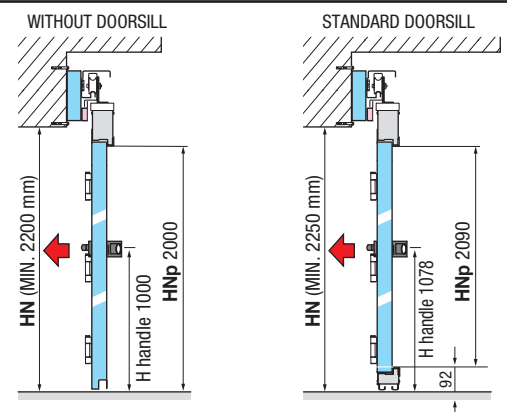
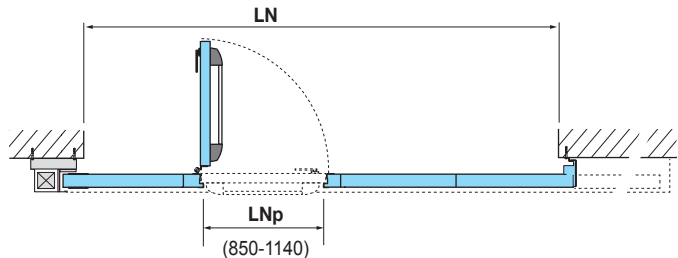

NOTE

- Low traffic flow fire compartmentation element not to be used improperly.
- Install in environments not subject to air drafts.
- Assembly to be carried out only by specialized personnel.
- Install only on perfectly square and level compartments or structures.
- For special cases indicate the spaces available and apply to our technical department.
- Precaution in use and risk analysis are the responsibility of the customer.
- Detection system, preferably centralized, to be provided by and at the expense of the customer.
- The panels, due to production requirements, may be un-

- ① For the actual overall dimensions, check sizes and / or apply to the technical department. In the case of sizes R and SP, overall dimensions are to be increased by minimum 105 mm.
- ② At door end overall dimensions are to be increased by 140 mm in case of CC 2800N electromagnet.
- ③ Minimum dimensions: indicate the available clearance, opening side, if it is around the minimum indicated.
- ④ For HN (net height) > 7150 the upper and lower reinforcing structure may have a different size from the usual one and the handle can be positioned higher.
- ⑤ Feasibility check for LN (net wall aperture) > 6000.
- ⑥ HN / HV is to be measured from finished floor elevation.
- ⑦ Solution possible for direct COUNTERBALANCE WEIGHT and one idler (sizes to be verified) and for LN (net wall aperture) 6000.
- ⑧ Solution possible only for symmetrical leaves with LN (net wall aperture) 8000 and for COUNTERBALANCE WEIGHT and one idler (sizes to be verified).
- ⑨ Apply to our technical department to check for feasibility.

- Drawings are provided by way of example therefore they are out of scale.
- The dimensions are expressed in millimeters.
- The protocol / file number will be attributed upon order or production confirmation.
- Meverin reserves the right to make any changes it deems appropriate to this document at any time and without notice.



SEE ACCESSORIES ON PAGE 7 →

ACCESSORIES

END OF TRAVEL DAMPER SAM K (Shock Absorber Magnetic)

TECHNICAL FEATURES:

The compression energy on the stem is absorbed by compressing the hydraulic fluid through an adjustable relief valve. The damper stem, once compressed, is automatically rearmed for a new cycle.

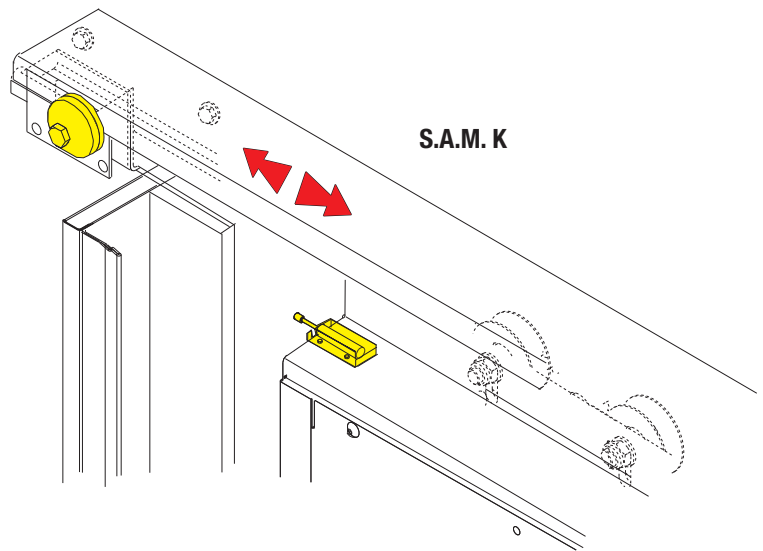

VTK - VISCOTROLLER® KALIPÈ® DOOR TRAVEL DAMPER



NB:
 Do not force the seal in order to avoid oil leaks.

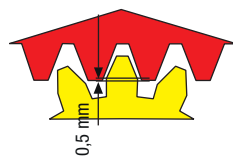
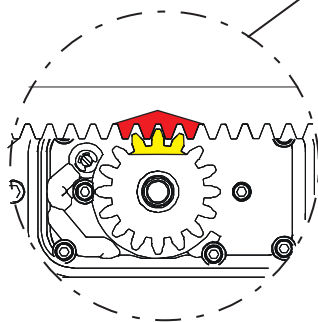

The door closing speed must be modulated by acting directly on the nozzle (D) (see installation, use and maintenance manual).

Adjust the height of the VTK door travel damper by means of the slots so that the pinion has sufficient play (0.5 mm) on the rack.

NB:
 The drive direction can be reversed by rotating the ROTOR (C) by 180°.

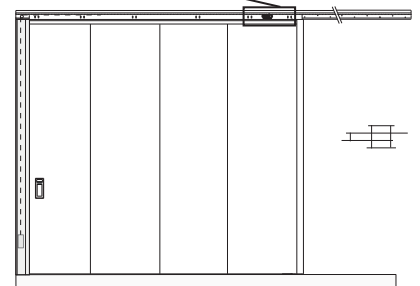
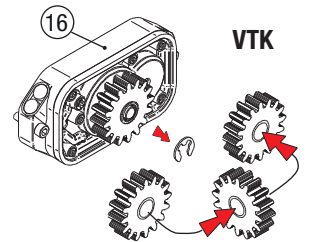

ELECTROMAGNET - ELM K

Model CC 1400N

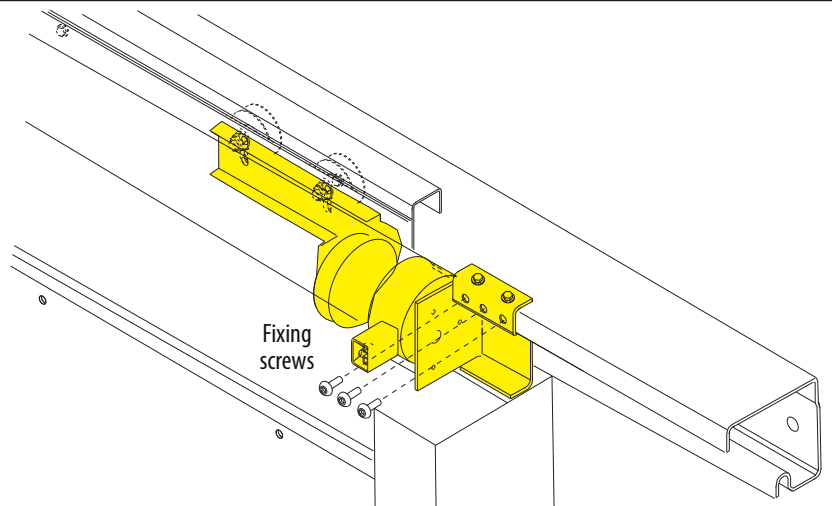

CONTINUE →

ACCESSORIES

STONE TRACK - CONTRAST SYSTEM

Innovative and patented lower **containment system - Stone Track** - designed for fire performance in the large dimensions.

RAL 3000 contrast plates^① to be positioned in line with the center distance of the opposition wheels^②

Patented
Meverin
system

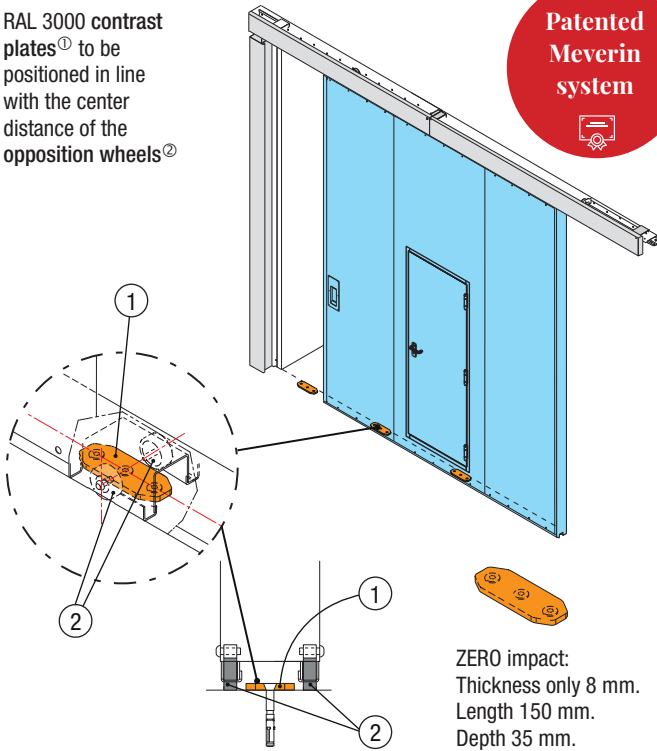

FLOOR GUIDE RAL 3000

(provided for LN -net wall aperture- 4900 mm)

Alternative ground restraint system to the advanced Stone Track system.
For EI₂ 60 doors, the length of the floor guide has been reduced to 1500 mm.

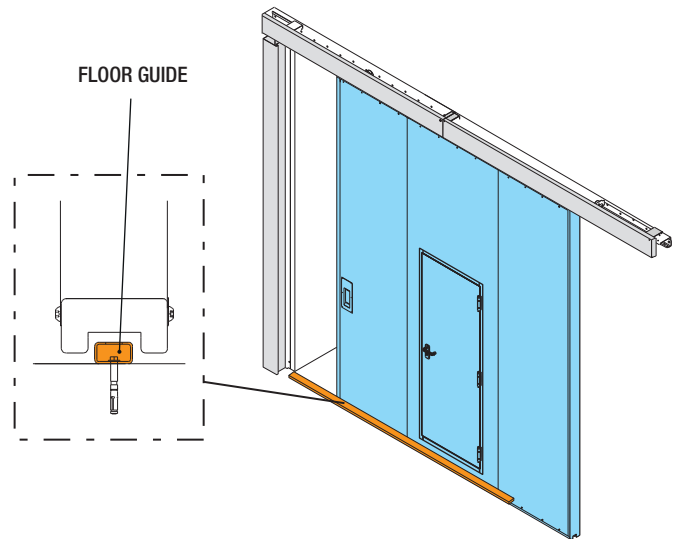

EXTERNAL NIGHT LOCK

Can only be opened on one side.

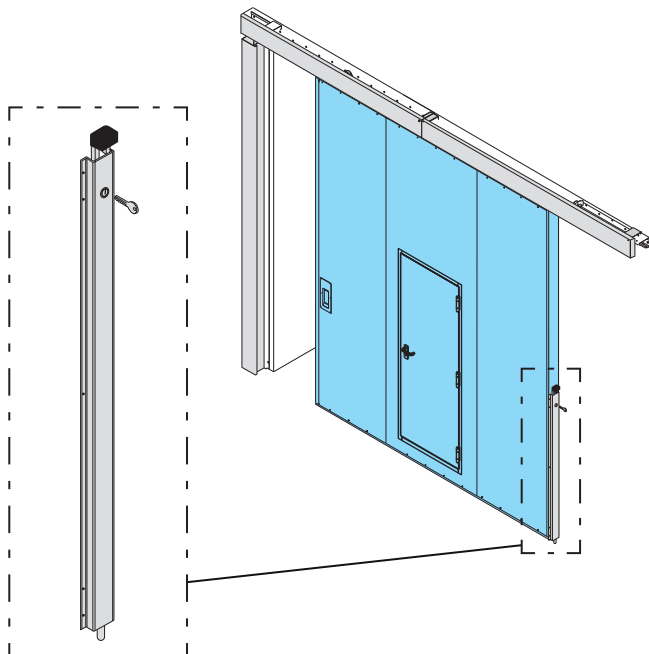

INTERNAL NIGHT LOCK

To be foreseen when placing the order.

Can be opened on both sides.

Feasibility check for 1 leaf with LN (net wall aperture) <700 mm.

Feasibility check for 2 symmetrical leaves with LN (net wall aperture) <1600 mm.

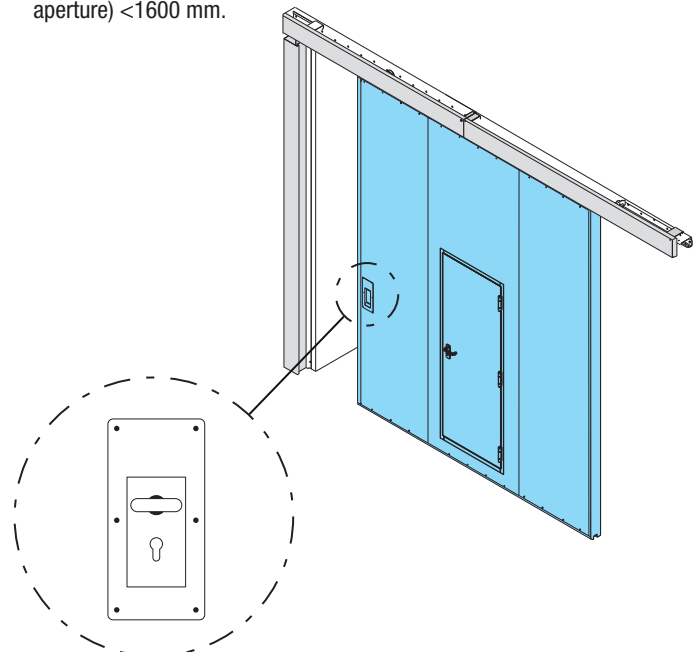

ACCESSORIES

PRIORITY FIRE[®] Motorization

Available for single-leaf sliding doors with a front or embedded on-leaf counterweight*, including a push-button panel with deadman operation and an emergency button.

This device must be interfaced with a fire detection system, preferably a centralized one, to be provided by the customer.

Available as an add-on to the Meverin CE Sliding range only for single-leaf doors with a front or on-leaf counterweight*.

*Due to production requirements, the integral counterweight may not be positioned at the end of the door leaf.

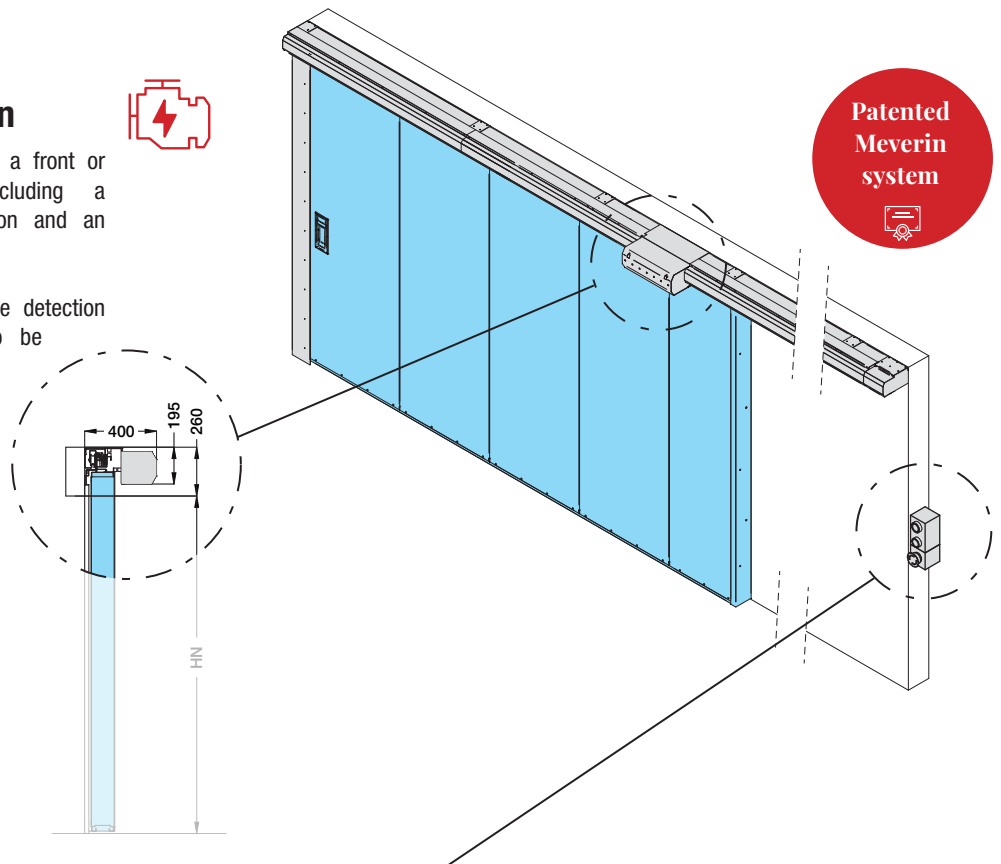

STD. KEYBOARD (3 PUSHBUTTONS)

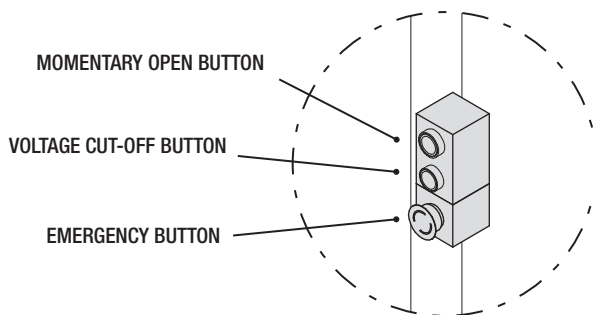

OPTIONAL KEYBOARD (4 PUSHBUTTONS)

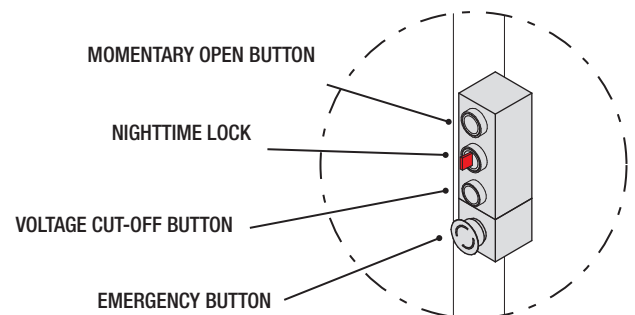

Concept and Purpose

PRIORITY FIRE is an innovative motorized device, designed and patented by Meverin, to improve the daily usability of the fire-rated sliding doors produced by the company. This system represents an **advanced technical solution** that allows for the automated opening of the sliding leaf, improving operational convenience in industrial and residential settings, without compromising one of the primary functions of fire compartmentalization: **self-closing**.

Operation and Integration

PRIORITY FIRE acts as a **utility for opening and holding the sliding door open**, thanks to an electromagnetic system. The device can be activated daily, upon opening, to facilitate passage, thus offering a significant **ergonomic and functional advantage** in the management of large fire openings.

The system, as with the ELM-K opening retaining system, **must be**

interfaced with a fire detection system, which should be implemented by a **qualified technician** appointed by the client.

In the event of fire detection:

- the detection system **commands the release** by interrupting the power supply to the **PRIORITY FIRE** device;
- the door **closes automatically by gravity**, thanks to a counterweight system, which acts as a latent force always ready to intervene.

Main advantages

- **Daily motorized opening** to simplify logistics and access.
- **Full compatibility** with Meverin fire doors.
- **Guaranteed safety**: in case of emergency, closing occurs in accordance with regulations, by means of a passive system (gravity and counterweight).
- **Patented solution**, a guarantee of exclusivity and technological innovation.

ACCESSORIES

ANCHORING BASE

ANCHORING BASE for dowel-ling to the ground, flush with the clear door opening, at the center of the sliding leaf closing-side.

Forseen for single-leaf sliding doors with a LN greater than 4900 mm.

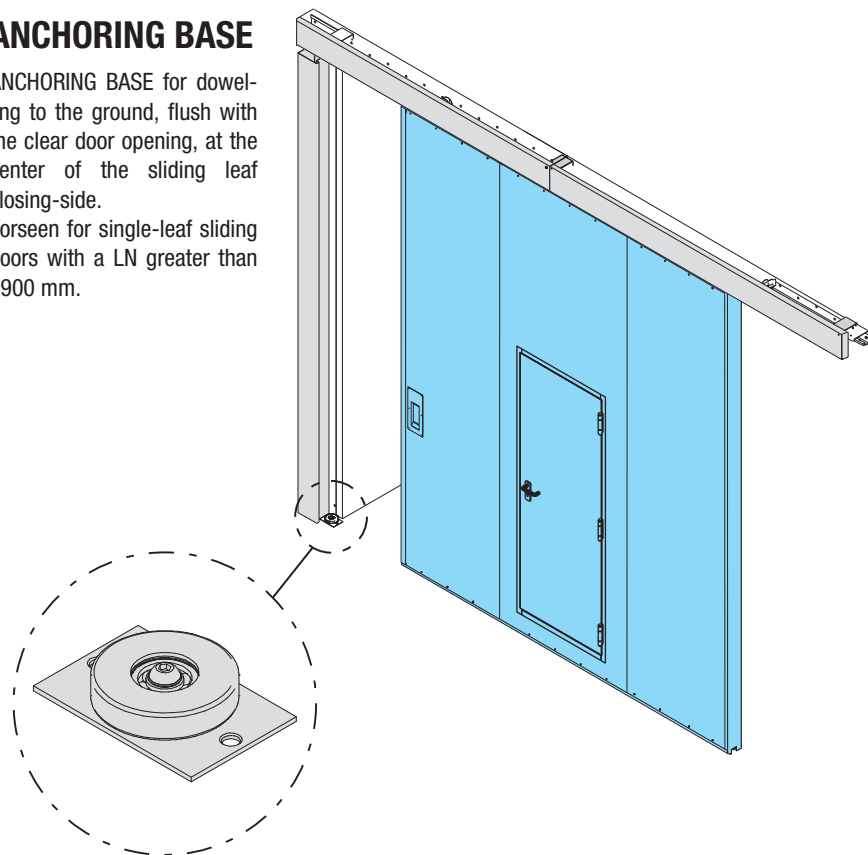

GLAZING

Optional panel with visual element

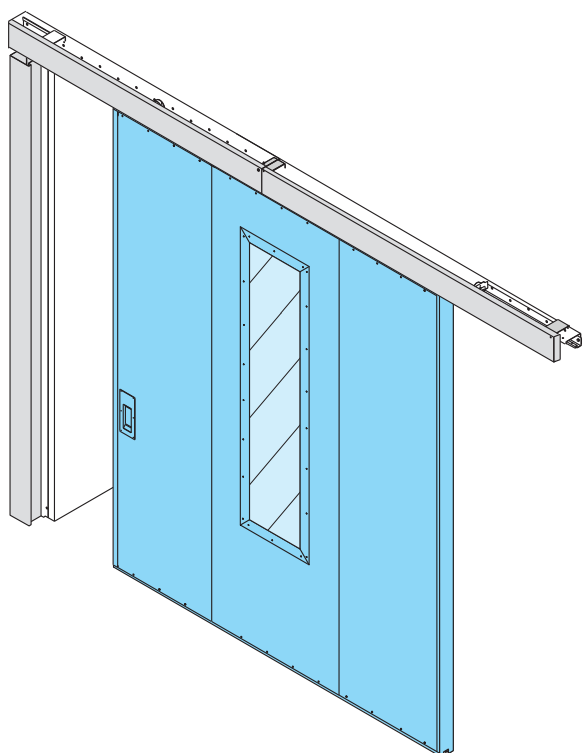

GLAZING

Optional pedestrian door with visual panel (porthole).

